

	-10°C...+70°C		-5°C...+35°C
---	---------------	---	--------------

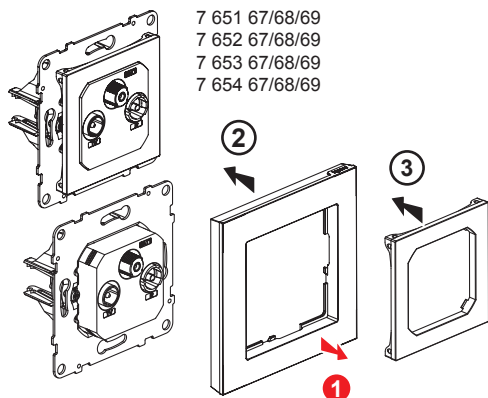

		cabling structure	Control	Return Path	Channel 1	Channel FM	Channel VHF	Channel UHF	Channel SAT (IF)
Z = 75 Ω	500 mA			22 kHz 0,6 V	4 - 30 MHz	47 - 68 MHz	87,5 - 240 MHz	120 - 470 MHz	470 - 862 MHz
7 650 65	-	star	1,5 dB	1,5 dB					
7 651 67/70 7 652 67/70 7 653 67/70 7 654 67/70	yes	star	1,5 dB	1,5 dB					2 dB
7 651 68 7 652 68 7 653 68 7 654 68	yes	pass	1,5 dB	14 dB					
7 651 69 7 652 69 7 653 69 7 654 69	yes	end	1,5 dB	10 dB					

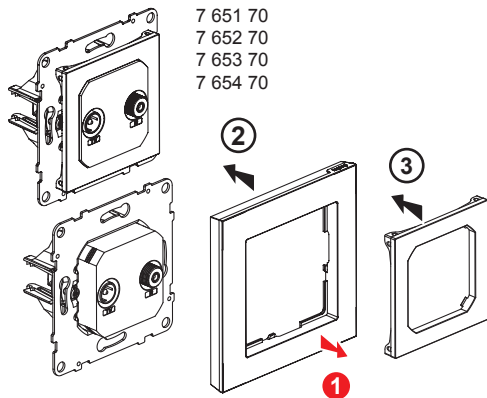
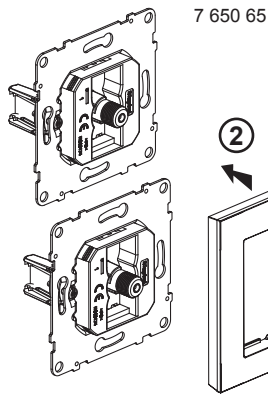
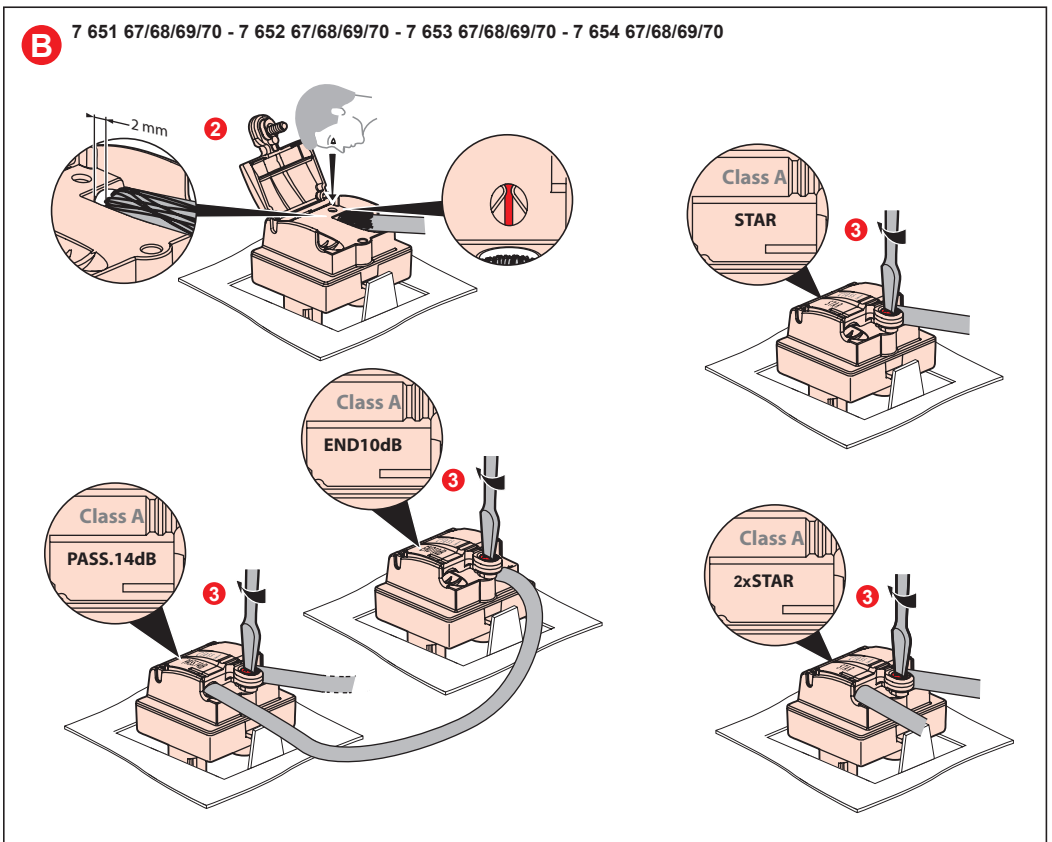
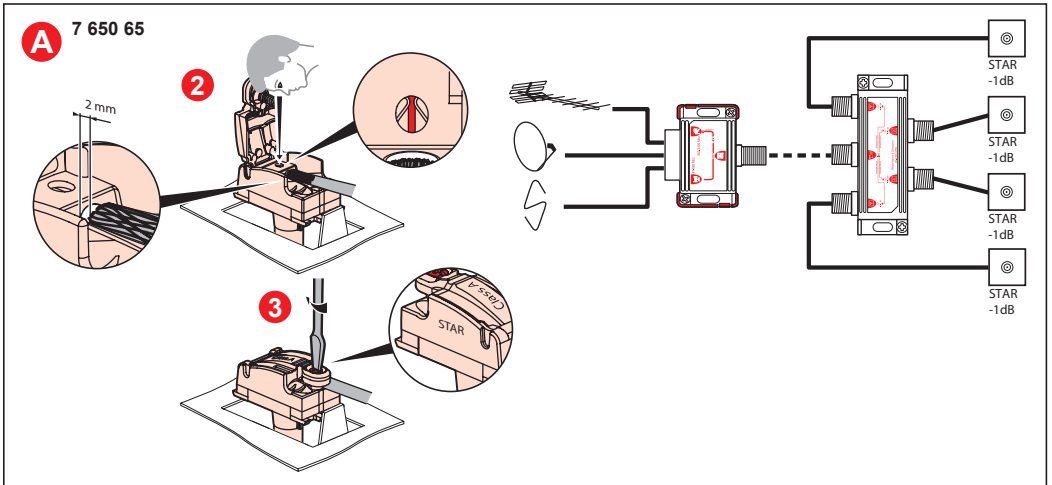
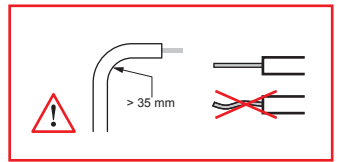
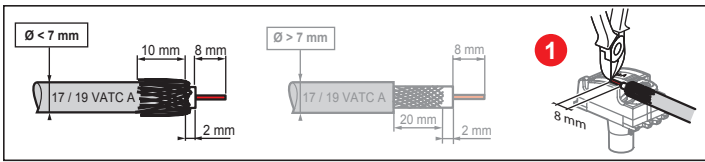
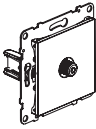
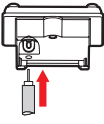
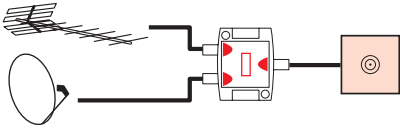
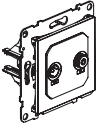
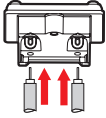
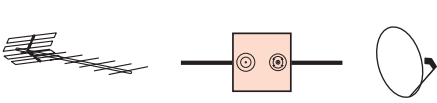
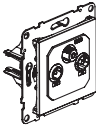
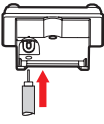
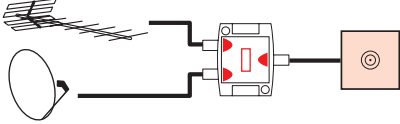
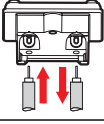
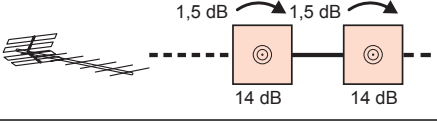

TV	7 650 65			
TV-SAT	... 70			
TV-R-SAT	... 67			
	... 68			
	... 69		