

Valena™ Life - Valena™ INMATIC
TV-R-SAT sockets

Cat. No(s): 7 530 52/62/63/64/65 - 7 531 52/64/65 - 7 532 52/64/65
7 533 52/64/65 - 7 563 52/64/65

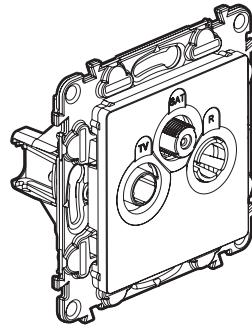

1. USE

TV/R/SAT + DAB⁺: for receiving TV, radio and satellite signals.
 UHD (ultra high definition) compatible.
 Class A shielded star sockets LTE Ready (4G protected).
 Recommended coaxial cable 17/19 VATC.
 Single cable entry.
 Can be flush mounted in a box min. 40 mm deep.
 To be equipped with plate.

2. RANGE

Designation	TV/R/SAT SOCKETS + DAB ⁺ - Mechanism + cover plate				Mechanism only
	White	Ivory	Aluminium	Black	
TV/R/SAT + DAB ⁺ Star socket	7 531 52	7 532 52	7 533 52	7 563 52	7 530 52
TV/R/SAT + DAB ⁺ socket - terminal	7 531 64	7 532 64	7 533 64	7 563 64	7 530 64
TV/R/SAT + DAB ⁺ socket - passthrough	7 531 65	7 532 65	7 533 65	7 563 65	7 530 65
TV/R socket - terminal	-	-	-	-	7 530 62
TV/R socket - passthrough	-	-	-	-	7 530 63

3. DIMENSIONS (mm)

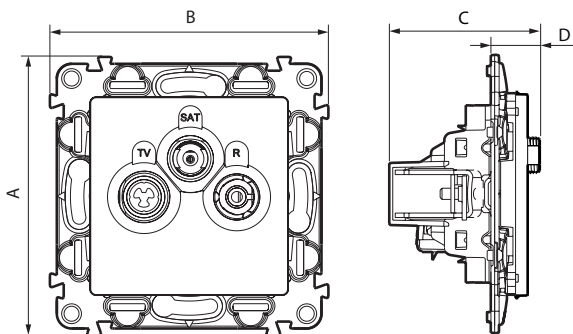

Cat. Nos	A	B	C	D
7 531 52/64/65 - 7 532 52/64/65 7 533 52/64/65 - 7 563 52/64/65 7 530 52/62/64/65	75	75	40	13
7 530 63	75	75	37	10

4. CONNECTION

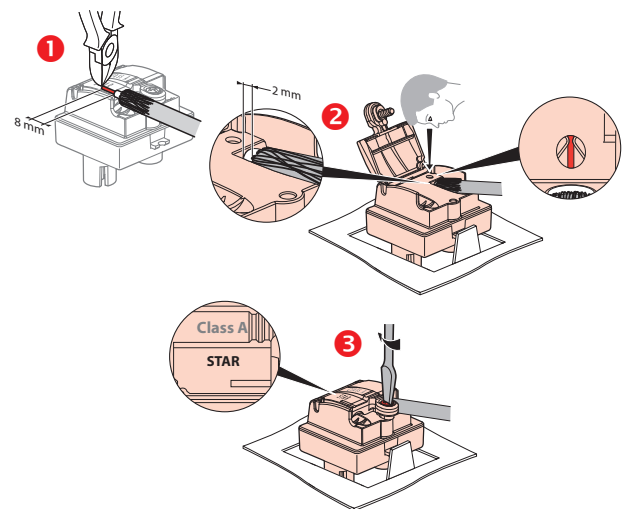

5. WIRING PRECAUTIONS

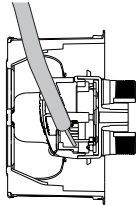
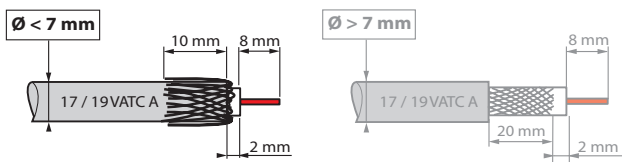

By restricting deformation of the coaxial cable, the rear connection avoids impedance discontinuity, thereby sustaining performance.

6. TECHNICAL CHARACTERISTICS

■ 6.1 Mechanical characteristics

Protection against impacts: IK 04

Protection against solid/bodies and liquids: IP 20

■ 6.2 Material characteristics

- Cover plate: White ABS RAL 9003
- Ivory ABS RAL 1013
- Painted ABS Aluminium and Black

Halogen-free

UV-resistant

- Motor: Casing: zamac

Cover: zamac

Pin: bronze

Screws: galvanized steel

Self-extinguishing: 650°C/30 s

■ 6.3 Electrical characteristics

- Male connector \varnothing 9.52 mm (TV)

- Female connector (Radio)

- Female F screw-type connector (SAT)

Characteristic impedance: 75 ohm

Class A shielding efficiency (class A shielding is necessary to prevent interference caused by using new 3 and 4 G phone signals, as these unwanted signals can result in pixellation on screen or adversely affect the sound track).

Frequency bands: TV: 5-68/320-862 MHz

R: 87.5-240 MHz

SAT: 950-2400 MHz

Attenuation: < 1.5 dB maximum

■ 6.4 Climate characteristics

Storage temperature: -10°C to +70°C

Usage temperature: -5°C to +35°C

7. CLEANING

Surface cleaning with a cloth.

Do not use acetone, tar remover, trichloroethylene.

Resistant to the following products: Hexane (NF C 61-314), Methylated spirit, soapy water, diluted ammonia, bleach diluted to 10 %, window-cleaning products, pre-impregnated wipes.

Caution: Always test before using special cleaning products.

8. STANDARDS AND APPROVALS

Compliant with installation and manufacturing standards.

See e-catalogue.

9. PERFORMANCES

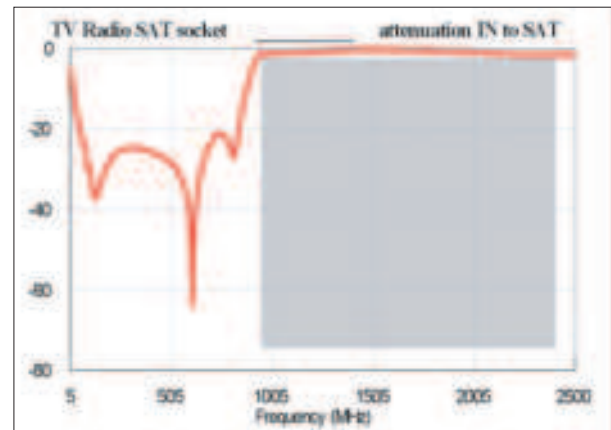
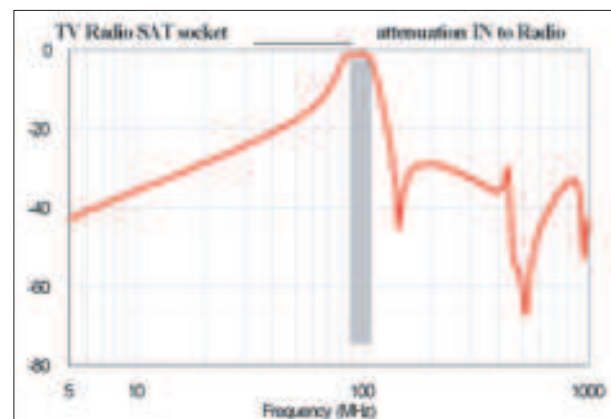
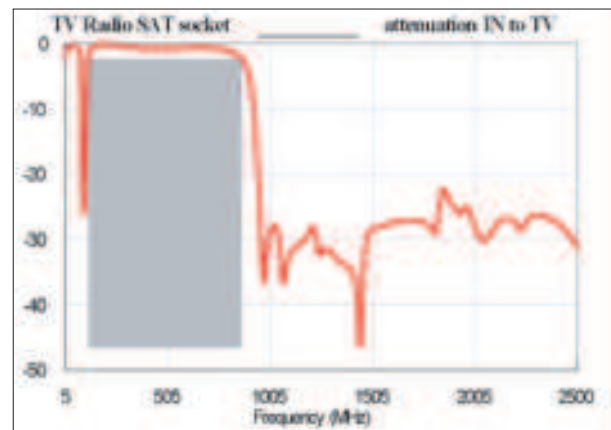

Prises TV Radio DAB

