

## TRACK

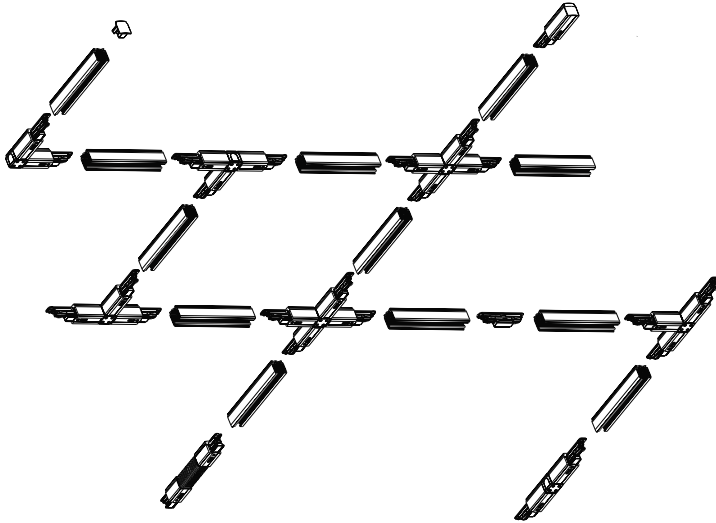

**DE** Bedienungsanleitung

**EN** User manual

**FR** Mode d'emploi

**ES** Instrucciones de uso

**IT** Istruzioni per l'uso

} [shop.dotlux.de](http://shop.dotlux.de) --> item-no --> Downloads

01/2022



## Produktdaten / Product data / Données sur le produit / Datos del producto / Dati del prodotto

<b>TRACK</b>	
Eingangsspannung/ Input voltage/ Tension d'entrée/ Tensión de entrada/ Tensione d'ingresso	400 V AC mehrphasig/ multiphase/ multiphase/ multifase/ multifase 230 V AC einphasig / single-phase/ monophasé/ monofásico/ monofase
Ausgangsstrom/ Output current/ Courant de sortie/ Corriente de salida/ Corrente di uscita	max. 16 A

3 Phasen-Stromschiene/ 3 phase busbar/ Jeu de barres triphasé/ Barra colectora trifásica/Sbarra di distribuzione a 3 fasi

### 3893-XX

- W1 = 1 m
- S1 = 1 m
- W2 = 2 m
- S2 = 2 m
- W3 = 3 m
- S3 = 3 m

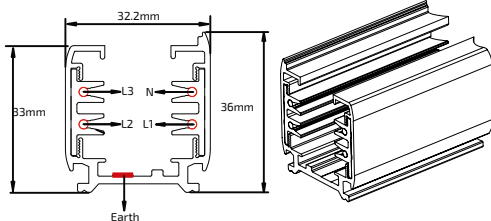

weiß/ white/ blanc/ blanco/ bianco

schwarz/ black/ noir/ negro/ nero

➔ rechts/ right/ droite/ a la derecha/ a destra

➔ links/ left/ gauche/ a la izquierda/ sinistra

## Lieferumfang / Scope of delivery / Étendue de la livraison / Alcance de la entrega / Ambito di consegna

- TRACK
- Bedienungsanleitung / User manual / Mode d'emploi /  
Instrucciones de uso / Istruzioni per l'uso

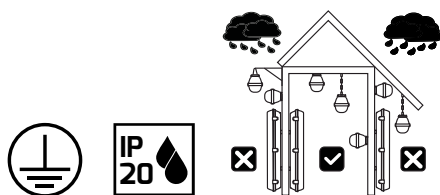

**DE****Bestimmungsgemäße Verwendung**

Das Produkt ist für den Einsatz innerhalb von Gebäuden vorgesehen.

**Konformität**

Hiermit erklärt DOTLUX GmbH, dass dieses Produkt den EU-Richtlinien EMC 2014/30/EU, LVD 2014/35/EU, RoHS 2011/65/EU und der Ökodesign-Richtlinie 2009/125/EG entspricht.

**EN****Intended use**

The product is intended for use inside buildings.

**Conformity**

DOTLUX GmbH hereby declares that this product complies with the EU Directives EMC 2014/30/EU, LVD 2014/35/EU, RoHS 2011/65/EU and the Ecodesign Directive 2009/125/EC.

**FR****Utilisation appropriée**

Le produit est destiné à être utilisé à l'intérieur des bâtiments.

**Conformité**

DOTLUX GmbH déclare par la présente que ce produit est conforme aux directives européennes EMC 2014/30/EU, LVD 2014/35/EU, RoHS 2011/65/EU et à la directive sur l'éco-conception 2009/125/CE.

**ES****Uso prescrito**

El producto está destinado a ser utilizado en el interior de los edificios.

**Conformidad**

DOTLUX GmbH declara por la presente que este producto cumple con las directivas de la UE EMC 2014/30/UE, LVD 2014/35/UE, RoHS 2011/65/UE y la Directiva de Ecodiseño 2009/125/CE.

**IT****Uso previsto:**

Il prodotto è destinato all'uso all'interno degli edifici.

**Conformità**

DOTLUX GmbH dichiara che questo prodotto è conforme alle direttive UE EMC 2014/30/EU, LVD 2014/35/UE, RoHS 2011/65/UE e alla direttiva sulla progettazione ecocompatibile 2009/125/CE.

3 Phasen-Stromeinspeiser/ 3-phase power feeder/ Injecteur de courant à 3 phases/  
Alimentador eléctrico trifásico/ Alimentatore trifase

**3894-XX**

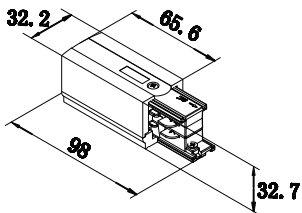
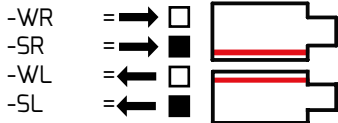

- Kabel: 5 x 1,25-2,5mm<sup>2</sup> oder 7 x 1,5-2,5mm<sup>2</sup>
- Kabel in 1 (geschraubte Kabelklemme der Einspeisung verwenden) oder 2 (Kabelverschraubung aus Kunststoff verwenden - nicht im Lieferumfang) einführen
- Kabelmantel 80mm entfernen - Leiterkabel 10-11 mm abisolieren
- Leiterkabel in Einspeisung - Markierung der Kontakte beachten

- Cable: 5 x 1.25-2.5mm<sup>2</sup> or 7 x 1.5-2.5mm<sup>2</sup>
- Insert cable into 1 (use screwed cable clamp of the feeder) or 2 (use plastic cable gland - not included in delivery)
- Remove 80mm cable sheath - Strip 10-11mm insulation from conductor cable
- insert conductor cable into feed - observe marking of contacts

- Câble : 5 x 1,25-2,5mm<sup>2</sup> ou 7 x 1,5-2,5mm<sup>2</sup>.
- Introduire le câble dans 1 (utiliser le serre-câble vissé de l'alimentation) ou 2 (utiliser un presse-étoupe en plastique - non fourni).
- Enlever la gaine du câble 80mm - Dénuder le câble conducteur 10-11 mm
- câble conducteur dans l'alimentation -observer le marquage des contacts

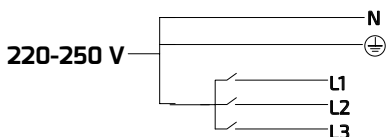
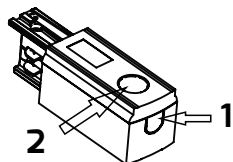
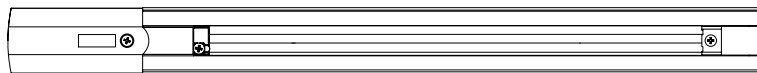
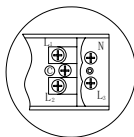

- Cable: 5 x 1,25-2,5mm<sup>2</sup> o 7 x 1,5-2,5mm<sup>2</sup>
- Inserte el cable en 1 (utilice la abrazadera de cable atornillada del alimentador) o en 2 (utilice el prensaestopas de plástico - no incluido en la entrega)
- Remover la cubierta del cable de 80mm -Pelar el aislamiento de 10-11mm del cable conductor
- insertar el cable conductor en la alimentación -observar la marca de los contactos

- Cavo: 5 x 1,25-2,5mm<sup>2</sup> o 7 x 1,5-2,5mm
- Inserire il cavo in 1 (utilizzare il morsetto a vite dell'alimentatore) o 2 (utilizzare il pressacavo in plastica - non incluso nella consegna)
- Rimuovere la guaina del cavo di 80 mm - Spellare l'isolamento di 10-11 mm dal cavo conduttore
- inserir il cavo conduttore nell'alimentazione -osservare la marcatura dei contatti



Endkappe/ End cap/ Embout/ Tapa final/ Tappo finale



**3895-X**

-W =   
 -S = 



3 Phasen-Verbinder/ 3 Phase connector/ Connecteur à 3 phases/ Conector trifásico/ Connettore a 3 fasi

**3896-X**

-W =   
 -S = 

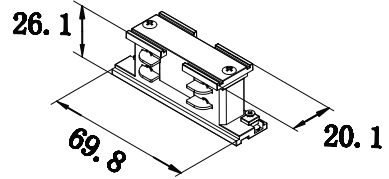

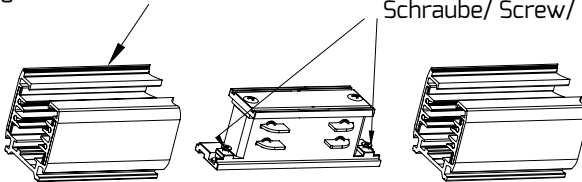

Führungslasche/ Guide lug/ Patte de guidage/ Ficha Guía/ Scheda Guida

Schraube/ Screw/ Vis/ Tornillo/ Vite



3 Phasen-Verbinder + Mitteleinspeisung/ 3 phase connector + centre feed/ Raccordement triphasé + alimentation centrale/ Conexión trifásica + alimentación central/ Collegamento trifase + alimentazione centrale





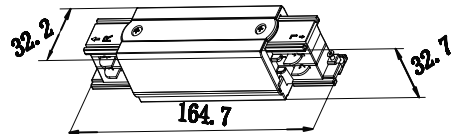



**3897-X**

-W =   
 -S = 



3 Phasen-Verbinder 90 °/ 3 Phase connector 90 °/ Connecteur à 3 phases 90 °/ Conector trifásico 90 °/ Connettore a 3 fasi 90 °

**3898-X**

-WR =    
 -SR =    
 -WL =    
 -SL =  

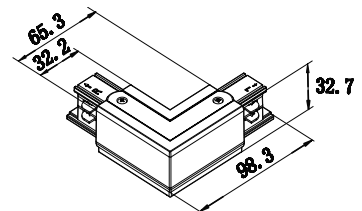



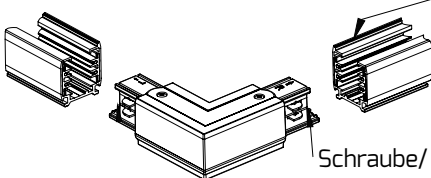





Führungslasche/ Guide lug/ Patte de guidage/ Ficha Guía/ Scheda Guida

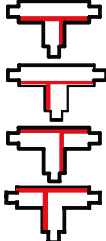

Schraube/ Screw/ Vis/ Tornillo/ Vite

3 Phasen-Verbinder T/ 3 Phase connector T/ Connecteur à 3 phases T/ Conector trifásico T/  
 Connettore a 3 fasi T

**3899-XX**

- WR1 = 1 m → □ 
- SR1 = 1 m → ■ 
- WL1 = 1 m ← □ 
- SL1 = 1 m ← ■ 
- WR2 = 2 m → □ 
- SR2 = 2 m → ■ 
- WL2 = 2 m ← □ 
- SL2 = 2 m ← ■ 

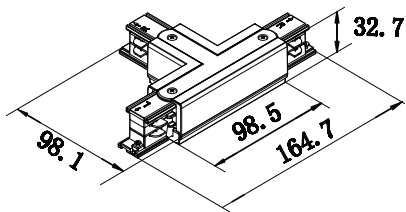

Schraube/ Screw/  
 Vis/ Tornillo/ Vite

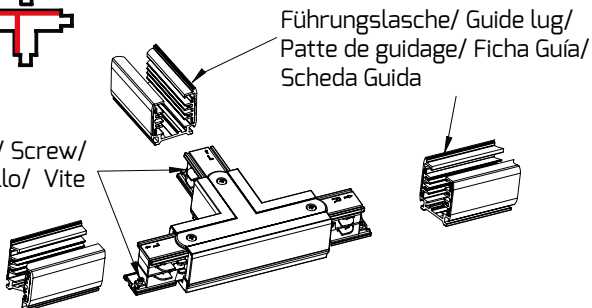

3 Phasen-Verbinder X/ 3 hase connector X/ Connecteur à 3 phases X/ Conector trifásico X/  
 Connettore a 3 fasi X

**3904-X**

- W = □ 
- S = ■ 

Führungslasche/ Guide lug/  
 Patte de guidage/ Ficha Guía/  
 Scheda Guida

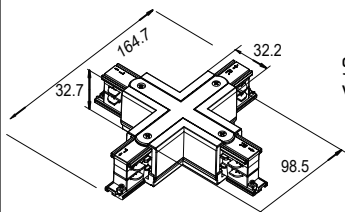

Schraube/ Screw/  
 Vis/ Tornillo/ Vite

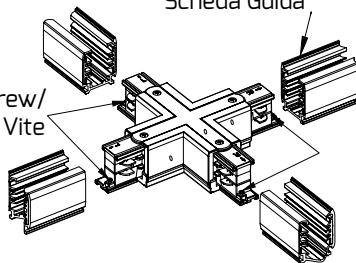

3 Phasen-Verbinder <360 °/ 3 hase connector <360 °/ Connecteur à 3 phases <360 °/  
 Conector trifásico <360 °/ Connettore a 3 fasi <360 °

**3905-X**

- W = □
- S = ■

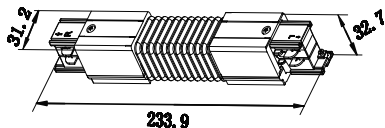

Stromführende Seite beachten/ Observe live side/ Attention au côté conducteur de  
 courant/ Observe el lado vivo/ Nota il lato vivo

3 Phasen-Verbinder <235 ° / 3 fase connector <235 ° / Connecteur à 3 phases <235 ° / Conector trifásico <235 ° / Connettore a 3 fasi <235 °

**3906-X**

-W =   
 -S =

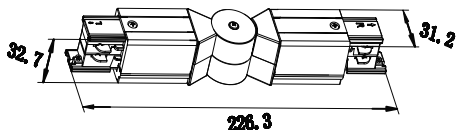

3 Phasen-Schienenabhängung PRO/ 3-phase track suspension PRO/ Suspension de rail à 3 phases PRO/ Suspensión de vía trifásica PRO/ Sospensione del binario a 3 fasi PRO

**5092-X**

-W =   
 -S =



3 Phasen-Schienenabhängung für Rasterdecken/ 3-phase track suspension for grid ceilings/ Suspension de rails à 3 phases pour plafonds modulaires/ Suspensión de carril trifásico para techos de rejilla/ Sospensione a binario trifase per soffitti a griglia

**3915-X**

-W =   
 -S =



3 Phasen-Versteifungselement/ 3 phase stiffening element/ Élément de raidissement à 3 phases/ Elemento de refuerzo trifásico/ Elemento di irrigidimento a 3 fasi

**4764-W**

=

**4766-S**

=



3 Phasen-Befestigungshaken <10 kg/ 3 phase mounting hook <10 kg/ Crochet de fixation à 3 phases <10 kg/ Gancho de montaje trifásico <10 kg/ Gancio di montaggio a 3 fasi <10 kg

**3914-X**

-W =   
 -S =



Empfohlener Befestigungsabstand/ Recommended mounting distance/ Distance de fixation recommandée/ Distancia de montaje recomendada/ Distanza di montaggio raccomandata → 1000 mm

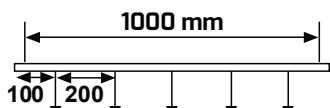

**Max. 50N 50N 50N 50N 50N**

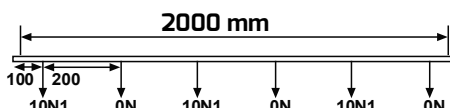

Zugfestigkeit/ Pull strength/ Force de traction/ Fuerza de tracción/ Forza di trazione:  
 100 N (1kp = 9,81N)

max. Drehmoment/ Max. torque/ couple max./ Par máximo/ Coppia massima: 2,5Nm

**Montagemöglichkeiten/ Mounting options/ Possibilités de montage/ Opciones de montaje/ Opzioni di montaggio**

**option 1**

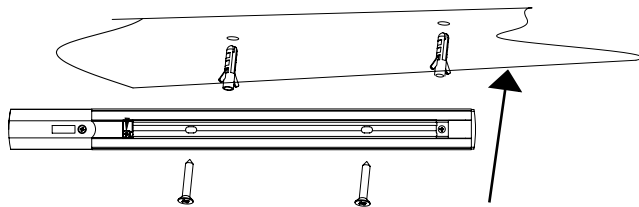

**option 2**

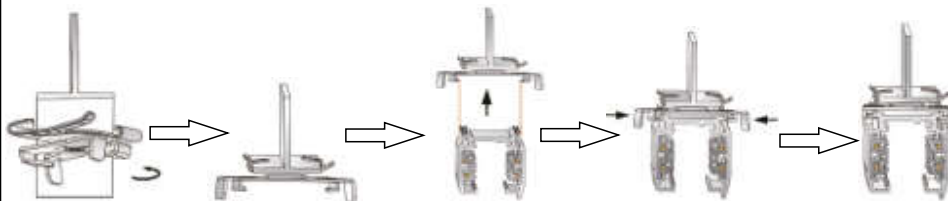

**option 3**

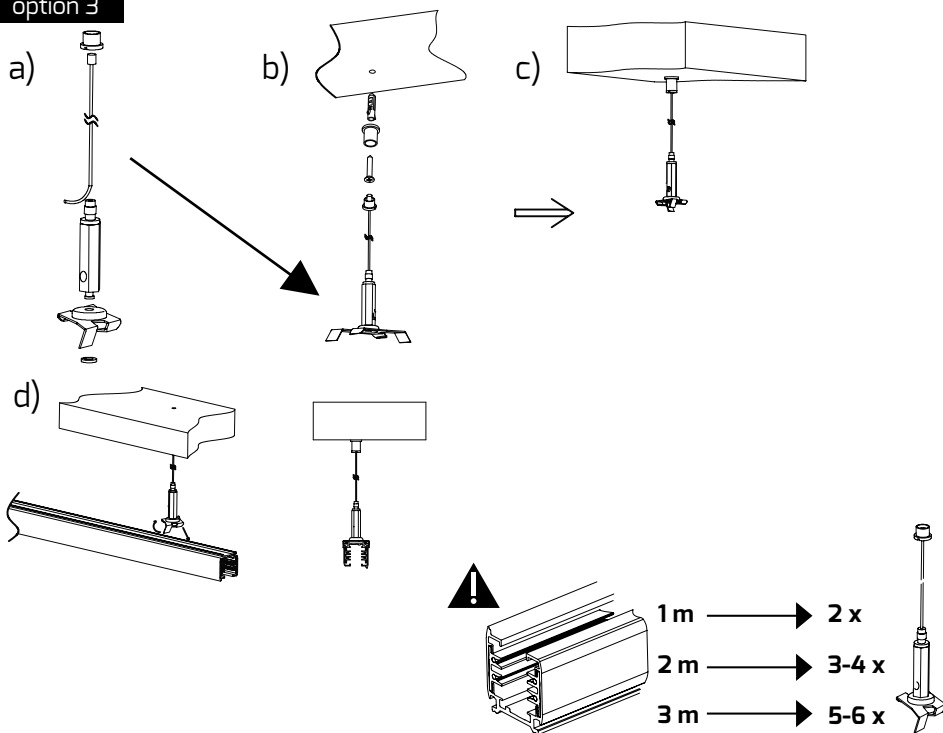



# Bedienungsanleitung

## Vor der ersten Benutzung / Haftungshinweise

Liebe Kundin, lieber Kunde, entpacken Sie das Produkt vorsichtig und prüfen Sie es auf Vollständigkeit und Unversehrtheit. Bei Beschädigungen am Kabel, Glas oder den elektrischen Teilen darf das Produkt nicht betrieben werden. Wenden Sie sich in solch einem Falle umgehend an die genannte Serviceadresse. Lesen Sie diese Anleitung sorgfältig durch. Sie vermeiden dadurch Fehler, die zu einer Gefahr oder Funktionsstörung führen könnten. Bewahren Sie die Anleitung für spätere Fragen auf. Geben Sie die Anleitung an jeden nachfolgenden Besitzer oder Benutzer des Produkts weiter. Stellen Sie sicher, dass gegebenenfalls jede erhaltene Ergänzung an die Anleitung beigefügt ist. Der Hersteller kann nicht für Personen- oder Sachschäden verantwortlich und/oder haftbar gemacht werden, die verursacht werden durch:

- unsachgemäße Montage
- vorgenommene Änderungen am Produkt
- nicht bestimmungsgemäße Verwendung
- Nichtbeachtung der vorliegenden Hinweise

## Konformitätserklärung

Der vollständige Text der EU-Konformitätserklärung ist unter der folgenden Internetadresse verfügbar:

<https://www.dotlux.de/konformitaetserklaerungen/>

## Weitere Symbole

Beachten Sie immer die Symbole auf der Verpackung und in dieser Montageanleitung.



Diese Anleitung setzt Fachkenntnisse voraus, die einer abgeschlossenen Ausbildung im Elektrowerk entsprechen.



**Achtung! Beachten Sie unbedingt die allgemeinen Sicherheits- und Warnhinweise.**



Die Lichtquelle ist nicht austauschbar. Die gesamte Leuchte muss ersetzt werden.



Die LED-Lichtquelle ist vom Endnutzer austauschbar.



Die LED-Lichtquelle ist von einer qualifizierten Person austauschbar.



Das Vorschaltgerät ist nicht austauschbar.



Das Vorschaltgerät ist vom Endnutzer austauschbar.



Das Vorschaltgerät ist von einer qualifizierten Person austauschbar.

## Bestimmungsgemäße Verwendung / Vorhersehbare Fehlanwendung

Angaben zur bestimmungsgemäßen Verwendung sind der Montageskizze zu entnehmen. Keine starken, mechanischen Beanspruchungen oder starker Verschmutzung aussetzen. Aus Sicherheitsgründen dürfen Sie das Produkt nicht verändern und/oder umbauen. Eine andere Verwendung, wie zuvor beschrieben, kann zur Beschädigung des Produktes führen. Dies kann Gefahren hervorrufen, wie z.B. Kurzschluss, elektrischer Schlag oder Brand.

## Reinigung/ Wartung



**Bei Reinigungs-/Wartungsarbeiten und vor dem Leuchtmittelwechsel muss die Leuchte unbedingt abkühlen und ausgeschaltet sein.**

Überprüfen Sie die Spannungsfreiheit. Zur regelmäßigen Reinigung (2-3 mal jährlich) verwenden Sie ein trockenes oder leicht angefeuchtetes Tuch und niemals Chemikalien oder Scheuermittel. Für Edelstahlleuchten empfiehlt sich die Verwendung eines Edelstahlreinigers. Verwenden Sie nur die auf der Verpackung angegebenen Leuchtmittel. Folgende umweltbedingte Einflüsse können unerwünschte Wirkungen auf die Oberfläche des Produktes haben: saurer Regen und Boden, hoher Salzgehalt in der Luft, Reinigungsmittel, Dünger (insbesondere in Blumenbeeten), Streusalz, andere chemische Substanzen (z.B. Pflanzenschutzmittel).

## Sicherheits- und Unfallverhütungsvorschriften

Beachten Sie für die Montage und die Wartung die nationalen Montage- und Unfallverhütungsvorschriften.



**Arbeiten Sie niemals bei anliegender Spannung an der Leuchte. Achtung - Lebensgefahr!**



Der elektrische Anschluss darf nur von einer Elektrofachkraft vorgenommen werden. Lassen Sie beschädigte elektrische Teile ausschließlich von einer Elektrofachkraft ersetzen.



**Dieses Produkt und seine Verpackung enthalten Kleinteile, die von Kindern verschluckt werden können. Halten Sie Kinder vom Produkt und der Verpackung fern!**



Ersetzen Sie umgehend jedes zerbrochene Schutzglas. Verwenden Sie dabei ausschließlich Originalteile.



Mindestabstand zu beleuchteten Gegenständen

## Hinweise zur Entsorgung



Ab dem Zeitpunkt der Umsetzung der europäischen Richtlinien 2012/19/EU und 2006/66/EG in nationales Recht gilt folgendes: Elektrische und elektronische Geräte sowie Batterien dürfen nicht mit dem Hausmüll entsorgt werden. Der Verbraucher ist gesetzlich verpflichtet, elektrische und elektronische Geräte sowie Batterien am Ende ihrer Lebensdauer an den dafür eingerichteten, öffentlichen Sammelstellen oder an die Verkaufsstelle zurückzugeben. Einzelheiten dazu regelt das jeweilige Landesrecht. Das Symbol auf dem Produkt, der Gebrauchsanleitung oder der Verpackung weist auf diese Bestimmungen hin. Mit der Wiederverwertung, der stofflichen Verwertung oder anderen Formen der Verwertung von Altgeräten/Batterien leisten Sie einen wichtigen Beitrag.

## Serviceadresse

DOTLUX GmbH  
Richard-Stuecklen Str. 7, 91781 Weissenburg  
Tel: +49 9141 / 4051 0  
Fax: +49 9141 / 4051 999  
info@dotlux.de  
www.dotlux.de

## Symbole Schutzart / Schutzklasse

	Schutzklasse I	Das Produkt hat einen Schutzleiteranschluss. Schließen Sie den Schutzleiter (grün-gelbe Ader) an die gekennzeichnete Erdungsschraube an.
	Schutzklasse II	Die Produkt ist besonders isoliert und darf nicht an einen Schutzleiter angeschlossen werden.
	Schutzklasse III	Die Produkt darf nur an Sicherheitskleinspannung angeschlossen werden.
	IP20	Schutz vor: Fremdkörpern mit $\varnothing \geq 12,5$ mm, Zugang mit den Fingern oder ähnlichen Gegenständen. <b>Kein Wasserschutz.</b>
	IP40	Schutz vor: Fremdkörpern mit $\varnothing \geq 1,0$ mm, Zugang mit Drähten oder ähnlichen Gegenständen bis 1,0 mm Dicke. <b>Kein Wasserschutz.</b>
	IP44	Schutz vor: Fremdkörpern mit $\varnothing \geq 1,0$ mm, Zugang mit Drähten oder ähnlichen Gegenständen bis 1,0 mm Dicke. Spritzwasser aus allen Richtungen (360°)
	IP54	Schutz vor: Staubablagerungen (in schädigender Menge), Spritzwasser aus allen Richtungen (360°), Vollständiger Schutz gegen Berührung
	IP65	Schutz vor: Staubeintritt (staubdicht), Strahlwasser aus einer Düse aus allen Richtungen (360°). Vollständiger Schutz gegen Berührung.
	IP66	Schutz vor: Staubeintritt (staubdicht), starkem Strahlwasser. Vollständiger Schutz gegen Berührung.
	IP67	Schutz vor: Staubeintritt (staubdicht), Eintauchen bei festgelegtem Druck und Zeit. Vollständiger Schutz gegen Berührung.
	IP69	Schutz vor: Staubeintritt (staubdicht), Schutz gegen Wasser bei Hoch-/ Dampfstrahlreinigung, speziell Landwirtschaft. Vollständiger Schutz gegen Berührung

## User manual

### Before Using / Notice of Liability

Dear customer,  
please unpack the products carefully and check that the delivery is complete and that the units are undamaged. Do not operate the product with a damaged electrical part, cable or glass. In cases of damaged components, you should contact the mentioned service address (point 9) immediately. Please read these instructions carefully. Thereby mistakes are avoided that could lead to hazards or malfunction. Keep the instructions and the installation manual in a safe place for future reference. The manual must be passed on to all subsequent owners or users of the product. Ensure that any supplements you may receive have also been appended to the manual. The manufacturer cannot accept any responsibility and/or liability for bodily injury or property damage due to:

- improper installaon
- unauthorized modification of the product
- improper use
- non-compliance with these instructions

### Declaration of Conformity

The full text of the EU declaration of conformity is available at the following Internet address:

<https://www.dotlux.de/konformitaetserklaerungen/>

### Other Symbols

Always follow the symbols on the packaging and in the instructions. The characters and symbols are explained below:





This manual assumes knowledge which corresponds to a complete training as an electrician.





**Attention! Basic safety precautions should always be followed.**

 The light source is not replaceable. The entire luminaire must be replaced.

 The LED light source is replaceable by the end user.

 The LED light source is replaceable by a qualified person.

 The ballast is not replaceable.

 The ballast is replaceable by the end user.

 The ballast unit can be replaced by a qualified person.

### Intended Use / Foreseeable Misuse

Please see the assembly drawing for further information concerning intended use. Do not expose to strong mechanical stress or heavy contamination. For safety reasons, do not modify and/or convert the product as any other use may damage the product. This could lead to hazards such as short circuit, electrical shock or fire.

### Maintenance/ Care



**Turn off the power and allow lamp to cool down before cleaning, maintaining or replacing the lamp!**

Check that there is no voltage. Use a dry or moist cloth for regular cleaning (2 or 3 times per year). Chemicals or abrasives must never be used. A special stainless steel cleaning agent is recommended for cleaning stainless steel luminaires. The following environmental influences can have undesirable effects on the surface of the product: acid rain and soil, high salt content in the air, cleaning agents, fertiliser (especially in flower beds), de-icing salt, other chemical substances (e.g. pesticides). Only the lamps stated on the packaging may be used.

## Safety Precautions

Please observe the national installation and safety regulations during installation, operation and maintenance.



**Do not install the lamp when voltage is applied to the lamp. Caution: Danger to life!**



Electrical connections may only be carried out by a qualified electrician. Damaged electronic parts may only be replaced by a qualified electrician.



**This product and its packaging contain small parts that can be swallowed by children. For this reason, the product and its packaging must always be kept out of reach of children.**



Replace any broken protective glass immediately. Always ensure that only original parts are being used.



Minimum distance to illuminated objects

## Disposal Instructions













After the implementation of European Directive 2012/19/EU and 2006/66/EG in the national legal system, the following applies: Electric and electronic devices as well as batteries must not be disposed of with household waste. Consumers are obliged by law to return electrical and electronic devices as well as batteries at the end of their service lives to the public collecting points set up for this purpose at the point of sale. Details to this are defined by the national law of the respective country. This symbol on the product, the instruction manual or the package indicates that the product is subject to these regulations. By recycling, reusing the materials or

other forms of utilising old devices/ batteries, you are making an important contribution to protecting our environment.

## Service Address

DOTLUX GmbH  
Richard-Stuecklen Str. 7, 91781 Weissenburg  
Tel: +49 9141 / 4051 0  
Fax: +49 9141 / 4051 999  
info@dotlux.de  
www.dotlux.de

## Symbols IP protection / Protection class

	Protection class I	The product has a connection for a protective earth conductor. Connect the protective earth conductor (green-yellow wire) to the corresponding marked earth screw.
	Protection class II	The product has special insulation and must not be connected to a protective earth conductor.
	Protection class III	The product may only be connected to safety extra-low voltage.
	IP20	Protection against: Solid objects with $\varnothing \geq 12.5$ mm, contact with fingers or similar objects. <b>No protection against liquid ingress!</b>
	IP40	Protection against: Solid objects with $\varnothing \geq 1.0$ mm, contact with wires, tools or similar objects with $\varnothing \geq 1.0$ mm. <b>No protection against liquid ingress!</b>
	IP44	Protection against: Solid objects with $\varnothing \geq 1.0$ mm, contact with wires, tools or similar objects with $\varnothing \geq 1.0$ mm. Splashed water from all directions (360°)
	IP54	Protection against: Dust deposition (of a harmful amount), all contact from solid objects. Splashed water from all directions (360°),
	IP65	Protection against: Dust ingress (dust-tight), all contact from solid objects. Water ingress caused by a nozzle (low pressure water jets) from all directions (360°).
	IP66	Protection against: Dust ingress (dust-tight), all contact from solid objects, powerful water jets
	IP67	Protection against: Dust ingress (dust-tight), all contact from solid objects, temporary immersion in water under defined conditions of pressure and time.
	IP69	Protection against: Dust ingress (dust-tight), protection against water in case of high pressure/ steam jet cleaning, especially agriculture, complete protection against contact.

## Mode d'emploi

### Avant la première utilisation/ Clause de non- responsabilité

Cher client,  
veuillez débiller soigneusement les produits et vérifier que la livraison est complète et que les unités ne sont pas endommagées. N'utilisez pas de produits dont la partie électrique, le câble ou le verre sont endommagés. Si des éléments sont endommagés, vous devez immédiatement vous adresser à l'adresse de service indiquée (point 9). Veuillez lire attentivement ces instructions. Cela permet d'éviter les erreurs qui pourraient entraîner des dangers ou des dysfonctionnements. Conservez les instructions et le manuel d'installation dans un endroit sûr pour pouvoir vous y référer ultérieurement. Le manuel doit être transmis à tous les propriétaires ou utilisateurs ultérieurs du produit. Assurez-vous que tous les suppléments que vous pourriez recevoir ont également été annexés au manuel. Le fabricant ne peut accepter aucune responsabilité et/ou obligation pour les dommages corporels ou matériels causés par :

- d'une installation incorrecte
- la modification non autorisée du produit
- utilisation abusive
- le non-respect de ces instructions

### Attention

La source lumineuse de ce luminaire n'est pas remplaçable; lorsque la source lumineuse atteint sa fin de vie, l'ensemble du luminaire doit être remplacé.

### Déclaration de conformité

Le texte complet de la déclaration UE de conformité est disponible à l'adresse internet suivante:

<https://www.dotlux.de/konformitaetserklaerungen/>

### Symboles utilisés

Veuillez toujours prêter attention aux sym-

boles sur l'emballage et sur la notice de montage. Voici la signification exacte des signes et symboles:



Cette notice impose certaines connaissances spécifiques qui nécessitent une formation spécialisée en électronique.



**Attention ! Veuillez impérativement respecter les recommandations et les avertissements concernant la sécurité.**



La source lumineuse n'est pas remplaçable. L'ensemble du luminaire doit être remplacé.



La source lumineuse LED est remplaçable par l'utilisateur final.



La source lumineuse LED est remplaçable par une personne qualifiée.

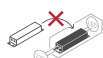

Le ballast n'est pas remplaçable.



Le ballast est remplaçable par l'utilisateur final.



Le remplacement du régulateur de puissance peut être effectué par une personne qualifiée.

### Utilisation conforme/ possible erreurs d'utilisation

Pour plus d'informations concernant l'utilisation conforme de ce produit, veuillez vous référer à la notice de montage- Vous trouverez plus d'informations concernant l'utilisation conforme dans le schéma de montage. Pour des raisons de sécurité, le produit ne doit être ni modifié, ni transformé. Une utilisation différente de celle décrite précédemment pourra entraîner la détérioration du produit et provoquer, par exemple, un court-circuit, un arc électrique, voire un incendie.

## Entretien/ Maintenance



**Pour le nettoyage et l'entretien, et avant de remplacer une ampoule, le luminaire doit impérativement avoir été débranché et avoir refroidi quelques minutes !**

Ce produit sert à l'éclairage. Pour le nettoyage régulier (2 à 3 fois par an), veuillez utiliser un chiffon propre et légèrement humide, mais jamais de produits chimiques ou récurrents. Pour les luminaires en inox, il est recommandé d'utiliser un produit de nettoyage pour inox.

Les effets environnementaux suivantes peuvent avoir un impact indésirable sur la surface du produit : pluies et soles acides, forte concentration de sel dans l'air, produits de nettoyage, engrais (en particulier dans les massifs), sel de déneigement, autres substances chimiques (par ex. produits phytosanitaires). N'utiliser que les ampoules indiquées sur l'emballage.

## Recommandation de sécurité et prévention

Pour le montage, l'entretien et la mise en service, veuillez observer la réglementation nationale en vigueur en matière de montage et de prévention des accidents.



**Ne manipulez jamais un luminaire sous tension – Danger de mort !**



Seul un personnel spécialisé est habilité à effectuer des branchements électriques. Les pièces électroniques endommagées doivent uniquement être remplacées par un personnel spécialisé.



**Ce produit et l'emballage comprennent des petites pièces susceptibles d'être avalées par les enfants. Veuillez tenir le produit et l'emballage hors de la portée des enfants !**



Veuillez remplacer immédiatement un verre de protection endommagé. Pour cela, utilisez uniquement des pièces originales.



Distance minimale aux objets éclairés

## Informations concernant le recyclage













Conformément à la directive européenne 2012/19/EU et 2006/66/CE, et afin d'atteindre un certain nombre d'objectifs en matière de protection de l'environnement, les règles suivantes doivent être appliquées: Les appareils électroniques ainsi que les batteries ne doivent pas être éliminés avec les déchets ménagers. Le pictogramme „picto“ présent sur le produit, son manuel d'utilisation ou son emballage indique que le produit est soumis à cette réglementation. Le consommateur doit retourner le produit / la batterie usager aux points de collecte prévus à cet effet. Il peut aussi le remettre à un revendeur. En permettant enfin le recyclage des produits ainsi que les batteries, le consommateur contribuera à la protection de notre environnement. C'est un acte écologique.

## Adresse du service

DOTLUX GmbH  
Richard-Stuecklen Str. 7, 91781 Weissenburg  
Tel: +49 9141 / 4051 0  
Fax: +49 9141 / 4051 999  
info@dotlux.de  
www.dotlux.de



## Symboles Protection IP/ classe de protection

	Classe de protection I	Le produit est doté d'un conducteur de protection. Connectez le conducteur de protection (fil vert-jaune) à la vis de prise de terre.
	Classe de protection II	Le produit dispose d'une isolation spéciale et ne doit pas être connecté à un conducteur de protection.
	Classe de protection III	Le produit ne doit être connecté qu'à une basse tension de sécurité.
	IP20	Protection contre l'intrusion de corps solides d'un diamètre supérieur ou égal à $\varnothing$ 12,5 mm, le contact avec les doigts ou les objets semblables. <b>Aucun protection contre l'intrusion d'eau !</b>
	IP40	Protection contre l'intrusion de corps solides d'un diamètre supérieur ou égal à $\varnothing$ 1,0 mm, le contact avec des câbles ou des objets semblables d'une épaisseur supérieur ou égale à 1mm. <b>Aucun protection contre l'intrusion d'eau !</b>
	IP44	Protection contre l'intrusion de corps solides d'un diamètre ou égal à $\varnothing$ 1mm, le contact avec des câbles ou des objets semblables d'une épaisseur supérieure ou égale à 1mm, les protections d'eau de toutes les directions (360°).
	IP54	Protection contre l'intrusion massive de poussière, le contact avec des câbles ou des objets semblables d'une épaisseur supérieure ou égale à 1 mm, les projections d'eau de toutes les directions (360°).
	IP65	Protection contre l'intrusion de poussière (hermétique à la poussière), le contact avec des câbles ou des objets semblables d'une épaisseur supérieure ou égale à 1mm, les jets d'eau provenant d'un tuyau dans n'importe quelle direction.
	IP66	Protection contre l'intrusion de poussière (hermétique à la poussière), le contact avec des câbles ou des objets semblables d'une épaisseur supérieure ou égale à 1mm, les jets d'eau puissants.
	IP67	Protection contre l'intrusion de poussière (hermétique à la poussière), le contact avec des câbles ou des objets semblables d'une épaisseur supérieure ou égale à 1mm, l'immersion dans l'eau à une pression donnée et pendant une certaine durée.
	IP69	Protection contre : Entrée de la poussière (étanche à la poussière), protection contre l'eau lors du nettoyage à haute pression/à jet de vapeur, en particulier dans l'agriculture, protection complète contre le contact.

## Instrucciones de uso

### Antes del primer uso/ Descargo de responsabilidad

Estimado cliente, Desembale cuidadosamente el producto y compruebe que está completo e intacto. Si el cable, el cristal o las piezas eléctricas están dañados, no utilice el producto. En tal caso, póngase en contacto con la dirección del servicio mencionado en el punto 9 inmediatamente. Por favor, lea estas instrucciones cuidadosamente. De esta manera se evitan errores que podrían llevar a un peligro o a un mal funcionamiento. Guarda el manual para futuras referencias. Transmita las instrucciones a cualquier otro propietario o usuario del producto. Asegúrese de que cualquier suplemento recibido se adjunta a las instrucciones. El fabricante no puede ser considerado responsable y/o responsable de las lesiones personales o daños a la propiedad causados por:

- instalación impropia
- los cambios realizados en el producto
- uso impropio
- la inobservancia de las presentes instrucciones

### Attention

La fuente de luz de esta lámpara no es reemplazable. Cuando la fuente de luz haya llegado al final de su vida útil, tiene que reemplazarse toda la lámpara.

### Declaración de conformidad

El texto completo de la Declaración de Conformidad de la UE está disponible en la siguiente dirección de Internet:  
<https://www.dotlux.de/konformitaetserklaerungen/>

### Otros símbolos

Observe siempre los símbolos del embalaje y de estas instrucciones de montaje:



Estas instrucciones requieren conocimientos especializados que corresponden a una formación completa en el oficio de electricista.



**¡Cuidado! Es esencial observar las instrucciones generales de seguridad y advertencia.**



La fuente de luz no es reemplazable. Debe sustituirse toda la luminaria.



La fuente de luz LED es reemplazable por el usuario final.



La fuente de luz LED puede ser sustituida por una persona cualificada.



El lastre no es reemplazable.



El lastre es reemplazable por el usuario final.



La unidad de lastre puede ser sustituida por una persona cualificada.

### Uso previsto/ Mal uso previsible

Para más información sobre el uso previsto, por favor, consulte el esquema de instalación. No se exponga a un fuerte estrés mecánico o a una gran suciedad. Por razones de seguridad no puede modificar y/o convertir el producto. Cualquier otro uso como el descrito anteriormente puede provocar daños en el producto. Esto puede llevar a peligros como un cortocircuito, una descarga eléctrica o un incendio.

### Limpieza/ Mantenimiento



**Durante el trabajo de limpieza/mantenimiento y antes de cambiar la bombilla, la fuentes de luz debe ser enfriada y apagada!**

Comprueba que no hay voltaje. Para la limpieza regular (2 a 3 veces al año) utilice un paño seco o ligeramente humedecido y nunca utilice productos químicos o limpiadores abrasivos. Se recomienda el uso de un limpiador de acero inoxidable para las luminarias de acero inoxidable. Utilice sólo las lámparas especificadas en el embalaje. Las siguientes influencias ambientales pueden tener efectos indeseables en la superficie del producto: la lluvia ácida y el suelo, alta salinidad en el aire, Detergentes, Fertilizante (particularmente en los parterres de flores), Sal para carreteras, otras sustancias químicas (por ejemplo, productos fitosanitarios).

## Normas de seguridad y prevención de accidentes

Para la instalación y el mantenimiento, observe las normas nacionales de instalación y prevención de accidentes.



**Nunca trabaje en la luminaria cuando se le aplique el voltaje. Atención - ¡Peligro de muerte!**



La conexión eléctrica sólo puede ser realizada por un electricista cualificado. Haga que las piezas eléctricas dañadas sean reemplazadas sólo por un electricista calificado.



**Este producto y su embalaje contienen pequeñas partes que pueden ser ingeridas por los niños. ¡Mantenga a los niños alejados del producto y su embalaje!**



Reemplace cualquier vidrio protector roto inmediatamente. Utilice sólo las piezas originales.



Distancia mínima a los objetos iluminados

## Instrucciones para desecho y reciclaje



Después de la puesta en marcha de la directiva Europea 2012/19/EU y 2006/66/EU en el sistema legislativo nacional, se aplicara lo siguiente: Los aparatos eléctricos y electrónicos, así como las baterías, no se deben evacuar en la basura doméstica. El usuario está legalmente obligado a llevar los aparatos eléctricos y electrónicos, así como pilas y pilas recargables, al final de su vida útil a los puntos de recogida comunales o a devolverlos al lugar donde los adquirió. Los detalles quedaran definidos por la ley de cada país. El símbolo en el producto, en las instrucciones de uso o en el embalaje hace referencia a ello. Gracias al reciclaje, al reciclaje del material o a otras formas de reciclaje de aparatos/ pilas usados, contribuye Usted de forma importante a la protección de nuestro medio ambiente.

## Dirección de servicio

DOTLUX GmbH  
Richard-Stuecklen Str. 7, 91781 Weissenburg  
Tel: +49 9141 / 4051 0  
Fax: +49 9141 / 4051 999  
info@dotlux.de  
www.dotlux.de

## Símbolos Grado de protección/ Clase de protección



Clase de protección  
I

El producto tiene una conexión a tierra protectora. Conecta el conductor protector (cable verde-amarillo) al tornillo de tierra marcado.



Clase de protección  
II

El producto está especialmente aislada y no debe ser conectada a un conductor de protección a tierra.



Clase de protección  
III

El producto sólo puede ser conectada a un voltaje extra bajo de seguridad.



IP20

Protección de: Los cuerpos extraños con  $\varnothing \geq 12,5$  mm, Acceso con los dedos u objetos similares. **No hay protección del agua.**



IP40

Protección de: Los cuerpos extraños con  $\varnothing \geq 1,0$  mm, Acceso con cables u objetos similares de hasta 1,0 mm de grosor. **No hay protección del agua.**



IP44

Protección de: Los cuerpos extraños con  $\varnothing \geq 1,0$  mm, Acceso con cables u objetos similares de hasta 1,0 mm de grosor, Salpicaduras de agua desde todas las direcciones (360°).



IP54

Protección de: Depósitos de polvo (en cantidades perjudiciales), Salpicaduras de agua desde todas las direcciones (360°). Protección completa contra el contacto.



IP65

Protección de: Entrada de polvo (hermético al polvo), Chorro de agua de una boquilla desde todas las direcciones (360°). Protección completa contra el contacto.



IP66

Protección de: Entrada de polvo (hermético al polvo), agua de chorro fuerte. Protección completa contra el contacto.



IP67

Protección de: Entrada de polvo (hermético al polvo), Inmersión a una presión y tiempo fijos. Protección completa contra el contacto.



IP69

Protección de: Entrada de polvo (estanco al polvo), protección contra el agua durante la limpieza a alta presión/chorro de vapor, especialmente en la agricultura, protección completa contra el contacto.

## Istruzioni per l'uso

### Prima del primo utilizzo / Disclaimer

Gentile cliente,

Disimballare con cura il prodotto e verificare che sia completo e intatto. Se il cavo, il vetro o le parti elettriche sono danneggiati, non utilizzare il prodotto. In questo caso, contattare immediatamente l'indirizzo di servizio di cui al punto 9. Si prega di leggere attentamente queste istruzioni. In questo modo si eviteranno errori che potrebbero portare a pericoli o malfunzionamenti. Conservare il manuale per riferimento futuro. Trasmettere le istruzioni a qualsiasi altro proprietario o utente del prodotto. Accertarsi che gli eventuali supplementi ricevuti siano allegati alle istruzioni. Il produttore non può essere ritenuto responsabile e/o responsabile per lesioni personali o danni alle cose causati da:

- installazione impropria
- modifiche apportate al prodotto
- uso improprio
- mancato rispetto di queste istruzioni

### Attention

La sorgente luminosa di questa lampada non deve essere sostituibile; quando la sorgente luminosa raggiunge la fine della sua vita utile, la lampada completa deve essere sostituita.

### Dichiarazione di conformità

Il testo completo della dichiarazione di conformità UE è disponibile su Internet all'indirizzo

<https://www.dotlux.de/konformitaetserklaerungen/>

### Altri simboli

Osservare sempre i simboli sull'imballaggio e nelle presenti istruzioni di montaggio:



Queste istruzioni richiedono conoscenze specialistiche che corris-

pondono ad una formazione completa nel settore dell'elettrotecnica.



**Attenzione! È indispensabile osservare le istruzioni generali di sicurezza e di avvertimento.**



La sorgente luminosa non è sostituibile. L'intero apparecchio deve essere sostituito.



La sorgente luminosa a LED è sostituibile dall'utente finale.

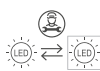

La sorgente luminosa a LED può essere sostituita da una persona qualificata.

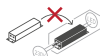

La zavorra non è sostituibile.



La zavorra è sostituibile dall'utente finale.



L'unità ballast può essere sostituita da una persona qualificata.

### Uso previsto /

### Uso improprio prevedibile

Per ulteriori informazioni sull'uso previsto, consultare lo schema di installazione. Non esporsi a forti sollecitazioni meccaniche o a forte sporcizia. Per motivi di sicurezza non è possibile modificare e/o convertire il prodotto. Qualsiasi altro uso descritto sopra può causare danni al prodotto. Questo può portare a pericoli come un corto circuito, scosse elettriche o incendi.

### Pulizia / Manutenzione



**Durante i lavori di pulizia/manutenzione e prima di sostituire la lampadina, la sorgente luminosa deve essere raffreddata espenta!**

Controllare che non ci sia tensione. Per una

pulizia regolare (da 2 a 3 volte all'anno) utilizzare un panno asciutto o leggermente umido e non utilizzare mai detergenti chimici o abrasivi. Per gli apparecchi in acciaio inossidabile si raccomanda l'uso di un detergente per acciaio inossidabile. Utilizzare solo le lampade specificate sulla confezione. I seguenti influssi ambientali possono avere effetti indesiderati sulla superficie del prodotto: pioggia acida e suolo, elevata salinità nell'aria, detergenti, fertilizzanti (in particolare sulle aiuole), sale stradale, altri prodotti chimici (ad es. prodotti fitosanitari).

### **Norme di sicurezza e prevenzione degli incidenti**

Per l'installazione e la manutenzione osservare le norme nazionali di installazione e prevenzione degli infortuni.



**Non lavorare mai sull'apparecchio quando viene applicata la tensione. Attenzione - Pericolo di morte!**



Il collegamento elettrico può essere effettuato solo da un elettricista qualificato. Far sostituire le parti elettriche danneggiate solo da un elettricista qualificato.



**Questo prodotto e la sua confezione contengono piccole parti che possono essere ingerite dai bambini - tenete i bambini lontano dal prodotto e dalla sua confezione!**



Sostituire immediatamente qualsiasi vetro di protezione rotto. Utilizzare solo parti originali.



Distanza minima dagli oggetti illuminati

### **Istruzioni per lo smaltimento e il riciclaggio**



Dopo l'attuazione della Direttiva Europea 2012/19/UE e 2006/66/UE nel sistema legislativo nazionale, si applicherà quanto segue: Le apparecchiature elettriche ed elettroniche e le batterie non devono essere smaltite nei rifiuti domestici. L'utente è obbligato per legge a portare i dispositivi elettrici ed elettronici, nonché le batterie e le batterie ricaricabili a fine vita nei punti di raccolta comunali o a restituirli al luogo in cui sono stati acquistati. I dettagli saranno definiti dalla legge di ogni paese. Il simbolo sul prodotto, nelle istruzioni per l'uso o sulla confezione si riferisce a questo. Riciclando le vostre apparecchiature o altri metodi di smaltimento, date un contributo significativo alla protezione del nostro ambiente.

### **Indirizzo del servizio**

DOTLUX GmbH  
Richard-Stuecklen Str. 7, 91781 Weissenburg  
Tel: +49 9141 / 4051 0  
Fax: +49 9141 / 4051 999  
info@dotlux.de  
www.dotlux.de

## Simboli Grado di protezione / Classe di protezione



Classe di protezione I

Il prodotto ha un collegamento a terra di protezione. Collega il conduttore di protezione (filo verde-giallo) alla vite di messa a terra contrassegnata.



Classe di protezione II

Il prodotto è isolata in modo speciale e non deve essere collegata ad un conduttore di terra di protezione.



Classe di protezione III

Il prodotto può essere collegata solo ad una bassissima tensione di sicurezza.



IP20

Protezione di: Corpi estranei con  $\varnothing \geq 12,5$  mm, Accesso con le dita o oggetti simili. **Nessuna protezione dall'acqua.**



IP40

Protezione di: Corpi estranei con  $\varnothing \geq 1,0$  mm, Accesso con cavi o oggetti simili fino a 1,0 mm di spessore. **Nessuna protezione dall'acqua.**



IP44

Protezione di: Corpi estranei con  $\varnothing \geq 1,0$  mm, Accesso con cavi o oggetti simili fino a 1,0 mm di spessore, Schizzi d'acqua da tutte le direzioni (360°).



IP54

Protezione di: Depositi di polvere (in quantità nocive), spruzzi d'acqua da tutte le direzioni (360°). Protezione completa contro il contatto.



IP65

Protezione di: Ingresso polvere (a tenuta di polvere), Getto d'acqua da un ugello da tutte le direzioni (360°) Protezione completa contro il contatto.



IP66

Protezione di: Ingresso di polvere (a tenuta di polvere), forte getto d'acqua. Protezione completa contro il contatto.



IP67

Protezione di: Ingresso polvere (a tenuta di polvere), Immersione a pressione e tempo fissi. Protezione completa contro il contatto.



IP69

Protezione di: Ingresso di polvere (a tenuta di polvere), protezione contro l'acqua durante la pulizia ad alta pressione/getto di vapore, soprattutto in agricoltura, protezione completa contro il contatto